

EN USER GUIDE

MICROWAVE OVEN

De Dietrich 

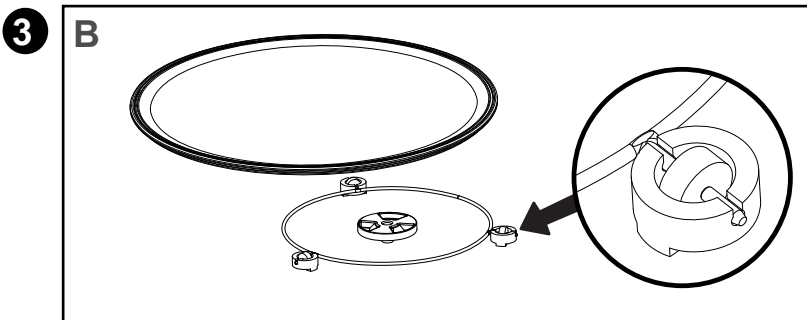

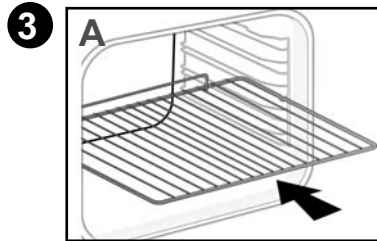
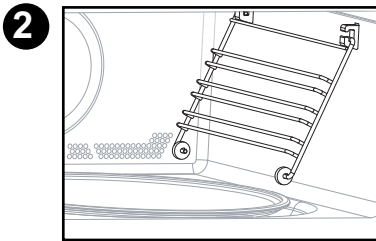
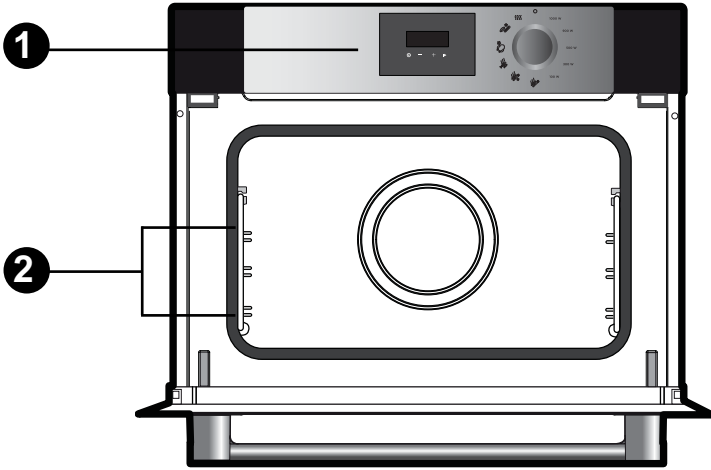

A

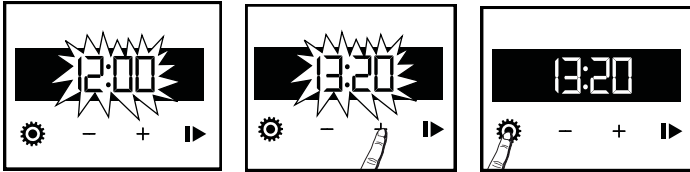

B

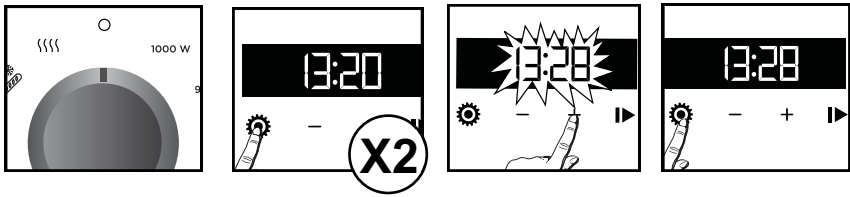

C

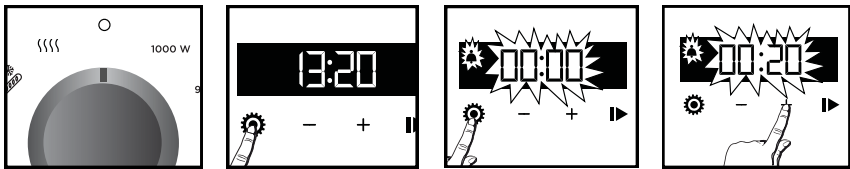

D

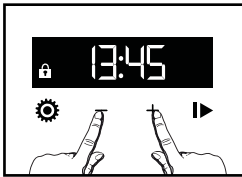

E

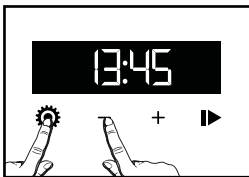

F

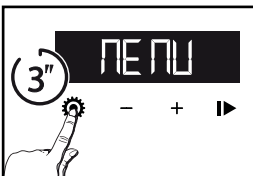

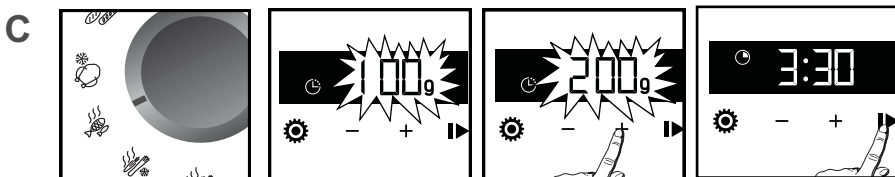
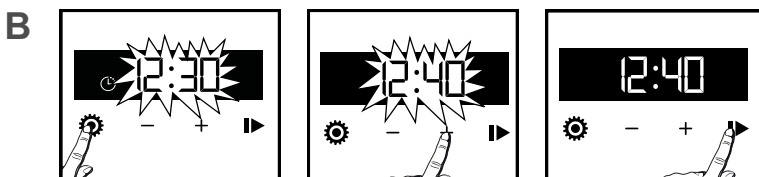
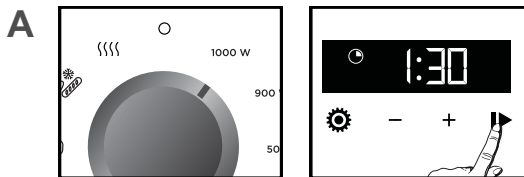



DEAR CUSTOMER,

Discovering a De Dietrich product means experiencing the range of unique emotions.

The attraction is immediate, from the moment you set eyes on the product.

The sheer quality of the design shines through, thanks to the timeless style and outstanding finishes which make each component an elegant and refined masterpiece in its own right, each one

in perfect harmony with the others. Next, comes the irresistible urge to touch it.

De Dietrich design makes extensive use of robust and prestigious materials, where the accent is placed firmly upon authenticity. By combining state-of-the-art technology

with top quality materials, De Dietrich produces beautifully crafted products to help you get the most from the culinary arts, a passion

shared by all lovers of cooking and fine food. We hope that you enjoy using this new appliance.

Thank you for choosing a De Dietrich product.

CONTENTS

Description of the oven	3
The control panel	3
The accessories.....	4
Settings	5
Setting the clock	5
Changing the clock	5
Minute Minder	5
Locking the controls.....	5
Stopping the turntable	5
Settings menu	6
Keep warm function	6
Cooking	7
Operating principle.....	7
Immediate cooking.....	7
Delayed start time	7
Automatic functions	8
Heating on 2 levels	8
Defrosting	9
Function suitability test	10
Care	10
Anomalies and solutions	11
Customer Service Department	12

DESCRIPTION OF THE OVEN



1 CONTROL PANEL

THE DISPLAY

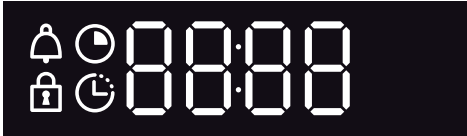

- Cooking time
- End of cooking
- Keypad lock
- Minute Minder

BUTTONS



1

-

2

+

3



4

- 1 Set clock and cooking time / menu
- 2 - button
- 3 + button
- 4 Start / Pause

THE KNOB

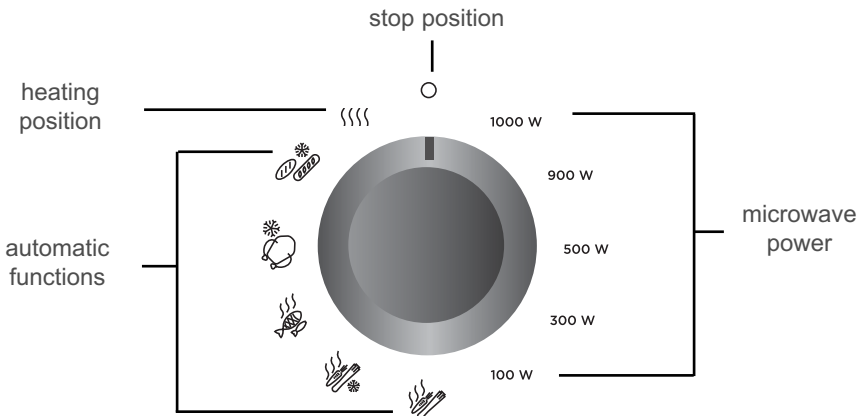

• 1 DESCRIPTION OF THE OVEN



FUNCTION SELECTOR DETAIL:

1000 W

Quick reheating drinks, water and dishes that contain a large quantity of liquid.

Cooking food that contains a lot of water (soups, sauces, tomatoes, etc.).

900 W:

Cooking fresh or frozen vegetables.

500 W:

Cooking fish and seafood.

Cooking dry vegetables over a low heat.

Reheating or cooking fragile egg-based foods.

300 W:

Cooking dairy products and jam at low heat.

100 W:

Defrosting pastries that contain cream.



: Cooking fresh vegetables.



: Cooking frozen vegetables.



: Cooking fish.



: Defrosting meat.



: Defrosting meat, poultry and ready meals.

⋮ Reheating:

Reheating position programmed at 2 minutes 30.

2 THE WIRE SHELF SUPPORTS

This oven has 3 shelf levels to place the rack at different heights (example for 2-level heating). See the shelf support removal diagram.

3 THE ACCESSORIES

- Anti-tip safety rack

(fig. A): The rack can be used to support all dishes and moulds containing food for cooking or browning. It can be used for grilling (placed directly on top).

Position the anti-tip stop towards the back of the oven.

• **The turntable (fig. B)** : ensures even cooking of food throughout, with no need to intervene. It rotates in both directions. If it does not turn, verify that all components are properly positioned. It may be used as a cooking dish. For easy removal, wells are provided on either side.

• **The turntable:** enables the glass plate to turn.

If you take out the support with the drive spindle, make sure you do not let water get into the motor spindle orifice. Remember to put back the support, the support wheels and the turntable.

Do not try to rotate the wheel support manually, as you could damage the drive system. If it does not turn

• 1 DESCRIPTION OF THE OVEN



smoothly, make sure that there is nothing in the well beneath the turntable.

• 2 SETTINGS



SETTING THE CLOCK (fig. A)

When switching on the display flashes at 12:00.



Set the clock with + or -.

Confirm with .

If there is a power cut, the clock flashes.

CHANGING THE CLOCK (fig. B)

The function selector switch must be in the 0 position.



Press ; the  symbol appears. Press  again. Adjust the clock setting with + or -.

Confirm with .

The cooking end time is automatically saved after a few seconds.

MINUTE MINDER (fig. C)

This function can only be used when the oven is off.

Press ; the  symbol appears. The minute minder flashes.



Set the minute minder with + or -.

Press  to confirm. The timer will then start.

Once the time has lapsed, there is a sound signal. To stop it, press any key. The time appears again in the display.

NB: NB: You can modify or cancel the timer at any time. To cancel, return to the timer's menu and set to 00:00.

LOCKING THE CONTROLS (fig. D) - Child safety

Press + and - at the same time until the  symbol appears on the screen. To unlock, press + and - until the  symbol disappears off the screen.

STOPPING THE TURNTABLE (fig. E)

If you think that the size of your dish is preventing it from turning correctly, programme the turntable's stop function before selecting a function or during cooking.

Press the  and - keys at the same time to stop the turntable rotating. The turntable's stopping is confirmed by a beep.

To restart it, press the  and - keys at the same time.





Tip:

You must turn the container and mix its contents halfway through the programme when the Stop turntable option is activated.



• 2 SETTINGS



SETTINGS MENU (fig. F)

You can adjust different settings on your oven (when it is not cooking). To do so: Hold down the  key until “MENU” is displayed. Press  again to scroll through the different settings.

Activate or de-activate the different parameters with + and -:

<p><i>Default settings</i></p> 	<p>Sounds - beeps: Position ON, sounds active. Position OFF, no sounds.</p>
	<p>DEMO mode: Activate/deactivate «DEMO» mode: demonstration mode used in display. Deactivate it to make your oven operational.</p>
	<p>Keep warm mode : ON position, function activated. OFF position, function deactivated.</p>

To exit the “MENU”, press  again.

KEEP WARM MODE

When you activate this function in the settings menu, it enables you to keep your dish warm for 15 minutes if you do not take it out of the oven immediately and if you do not press any keys.



OPERATING PRINCIPLE

The microwaves used for cooking are electromagnetic waves. They are commonly found in our environment in the form of radio waves, light and infrared rays.

Their frequency is in the 2450 MHz range.

Their behaviour:

- They are reflected by metals.
- They travel through all other materials.
- They are absorbed by water, fat and sugar molecules.

When food is exposed to microwaves its molecules begin moving rapidly, causing it to heat up.

The penetration depth of waves into the food is approximately 2.5 cm; if the food is thicker, the centre of the food will be cooked by conduction, as in conventional cooking.

Note that microwaves cause a simple thermal phenomenon within food and are not harmful to health.

 **Warning:**
Do not use any metal containers or aluminium trays.

IMMEDIATE COOKING (fig. A)

Open the door. Set the dish inside and close the door.

If the dish is too large to turn freely inside the oven, deactivate the turntable's rotation before or during the programme.

5 microwave power levels are available :

100 (defrost) - 300 - 500 - 900 - 1000 Watts.

- Turn the function selector to choose the required power.

The display flashes and a cooking time is displayed according to the cooking mode.

- Confirm with the ► key; the cooking starts and the countdown is displayed.

Your oven has the "SMART ASSIST" function which, when programming a cooking time, will suggest a cooking time which can be modified depending on the selected cooking mode.

You can modify the cooking time with the + and - keys.

DELAYED START (fig. B)

Select a cooking mode. Change the cooking time if necessary.

Press . The end of cooking symbol flashes to indicate that it can be set.





You can modify the end of cooking time with the + and - keys.

Confirm with ►.



AUTOMATIC FUNCTIONS (Fig. C)

The automatic functions select the appropriate cooking parameters for you based on the food being prepared and its weight. Select a pre-programmed food from the following list:

-  : Cooking fresh vegetables.
-  : Cooking frozen vegetables.
-  : Cooking fish.
-  : Defrosting meat *.
-  : Defrosting meat, poultry and ready meals *.

* *These positions do not allow a delayed start.*

- Turn the function selector to the automatic function of your choice.
- Enter the weight of the food with + and - (in 50g steps) then confirm by pressing ►.

The oven starts.

By pressing , you access the cooking end time setting (See the delayed start chapter).

HEATING ON TWO LEVELS

You may heat 2 plates at the same time. In this case, put one plate on the turntable and the other on the 3rd shelf of the grill.

Tips:

Cover the plates with special microwave film, a plate cover or another plate placed upside-down on the first:

- **To obtain the most even reheating.**
- **To avoid the food drying out.**
- **To reduce the reheating time.**
- **To prevent food spatter in the oven.**

The foods keep all their flavour due to the steaming effect.



DEFROSTING

Using your micro-wave oven to defrost frozen food saves you a lot of time. To defrost food, use the MICROWAVE function set to power level 100 W.

What you need to know:

Small cuts of meat or fish can be cooked immediately after defrosting. Larger pieces such as meat joints or whole fish will still be slightly frozen after the defrost programme.

We recommend that you let the food stand for a period of time at least equal to the defrosting time to ensure an even temperature.

Food covered with ice crystals will take longer to defrost. In this case, you should increase the defrosting time.

A few tips:

The defrosting time also depends on the shape, size, starting temperature and quality of the food.

In most cases, food must be removed from its packaging. Remember to remove any metal staples from the packaging.

Halfway through defrosting, the pieces of food should be turned over, stirred and separated if they were frozen together.

If you are defrosting large pieces of meat or fish that prevent rotation of the turntable, use the turntable stop function. In this case, turn the food regularly.

Defrost meat or fish by putting it on an upside-down saucer on top of a plate to let the juices run. If they stay in contact

with the food, they will overheat. Never refreeze food before cooking it.

Defrost programme time:

Defrost programme times are calculated for food frozen at -18°C. This gives you an indication of the required defrosting time, but the actual time may vary based on the thickness, shape, size and packaging of the food.

• 3 COOKING



FUNCTIONAL SUITABILITY TESTS IN ACCORDANCE WITH IEC/EN/NF EN 60705 STANDARDS:

Test	Load	Approx. time	Power selector	Cookware/Tips
Custard (12.3.1)	1000 g	16 - 18 min	500 W	Pyrex 227 On the turntable
Savoie cake (12.3.2)	475 g	6 - 7 minutes	700 W	Pyrex 827 On the turntable
Meatloaf (12.3.3)	900 g	14 min	700 W	Pyrex 838 Cover with plastic film. On the turntable
Defrosting meat (13.3)	500 g	11 - 12 min	200 W	On a flat plate On the turntable
Defrosting raspberries (B.2.1)	250 g	6 - 7 min	200 W	On a flat plate On the turntable

• 4 CARE



CLEANING THE INNER AND OUTER SURFACES

We recommend that you clean the oven regularly and remove any deposits of food inside and outside of the appliance. Use a damp sponge and a little soap. If the appliance is not cleaned regularly, its surface could become damaged, permanently affecting the appliance's lifespan and possibly causing a safety

hazard.

The use of abrasive products, alcohol or thinners is not recommended as they are likely to damage the appliance.

If the door or door seal are damaged, the oven should not be used until it has been repaired by a qualified person.

If the oven smells bad or is dirty, boil a cup of water with lemon juice for 2 minutes and clean the walls with a small

• 4 CARE



amount of washing up liquid.

The turntable can be removed for easy cleaning. To remove it, pick it up using the access zones provided for this purpose. If you take out the support with the drive spindle, make sure you do not let water get into the motor spindle orifice. Remember to put back the support, the support wheels and the turntable.

REPLACING THE LAMP

For all operations on the lamp, contact the After Sales Department or a qualified professional accredited to work on the brand.

• 5 ANOMALIES AND SOLUTIONS



The appliance does not start.

Check that your appliance is plugged in properly.

Check that the oven door is properly closed.

The appliance is noisy.

The turntable does not rotate properly.

Clean the wheels and the rolling area under the turntable.

Ensure that the wheels are properly positioned.

You see steam on the window.

Wipe away the condensation with a cloth.

Food is not heated during a microwave programme.

Ensure that the utensils are suitable for microwave ovens and that the power level

is suitable.

There are sparks coming from the appliance.

Clean the appliance properly: remove any grease, food deposits, etc.

Remove any metal items from the walls of the oven.

The oven is not heating. Check that the oven is correctly connected and that your installation's fuse is not out of service. Check that the oven is not set to «DEMO» mode (see settings menu).

- The cooling fan continues to operate after the oven stops. This is normal. The ventilation may operate for several minutes after cooking to cool down the oven gradually.

• 6 AFTER-SALES SERVICE



SERVICING AND REPAIRS

Any repairs to your appliance must be made by a qualified professional accredited to work on the brand. When calling, please provide the full references of your appliance (commercial reference, service reference, serial number), so that we can handle your call better. This information appears on the manufacturer's nameplate on the equipment.

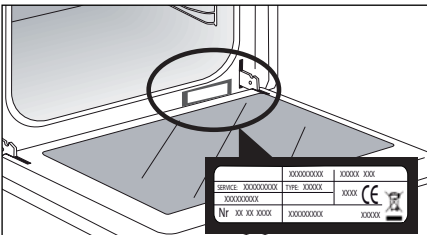

A	B
SERVICE : C	TYPE : D
E	F
Nr. H	

- B: Commercial reference
- C: Service reference
- H: Serial number